

# Data Sheet



Article number: 021816011115

Description: Clamp with bracket and rubber  
SPGU 6011. 115/30 SK

## Measures

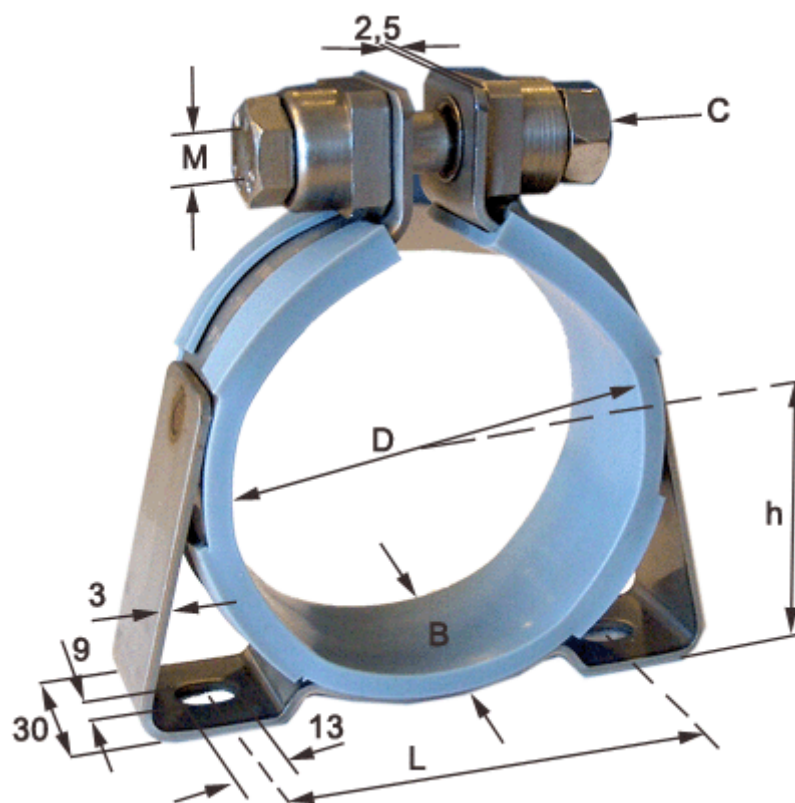

C (screw type) = SK hexagon screw

Diameter D = 115

h = 66

L = 100

Width B = 30